

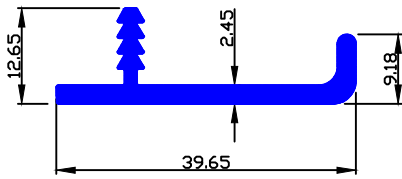

ALUMETAL INDUSTRIES

SEC. NO:- 1701

SEC. NO:-AI-71



WEIGHT:- 1.350-1.550 kg/12'

SEC. NO:- 1711

SEC. NO:-AI-72

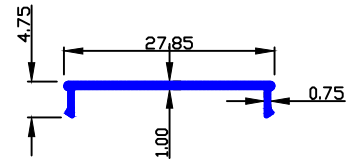

WEIGHT:- 0.330-0.530 kg/12'

SEC. NO:- 1721

SEC.NO:-AI-308

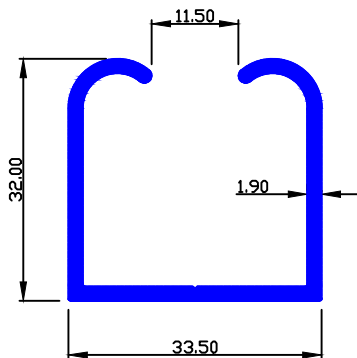

WEIGHT:- 2.000-2.200 kg/12'

SEC. NO:- 1731

SEC.NO:-AI-309

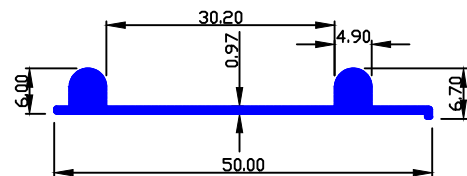

WEIGHT:- 0.900-1.100 kg/12'



ALUMETAL INDUSTRIES

SEC. NO:- 1741

SEC.NO:-AI-310

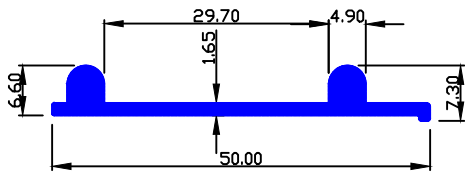

WEIGHT:- 1.250-1.450 kg/12'

SEC. NO:- 1751

SEC.NO:-AI-311

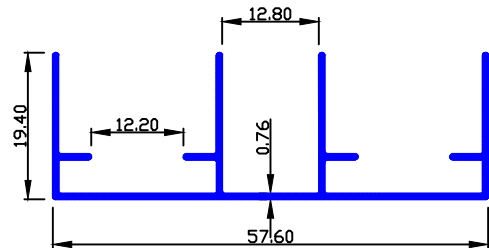

WEIGHT:- 1.100-1.300 kg/12'

SEC. NO:- 1761

SEC.NO:-AI-312

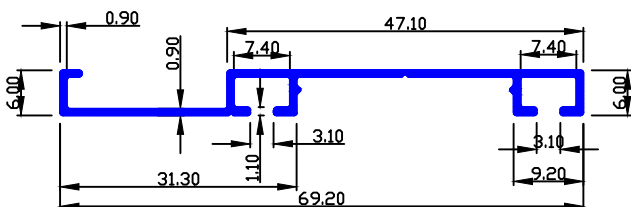

WEIGHT:- 0.950-1.150 kg/12'

SEC. NO:- 1771

SEC.NO:-AI-313

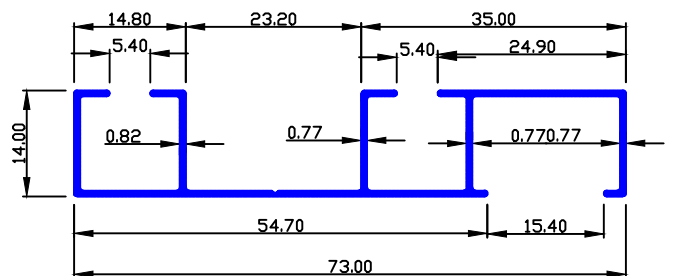

WEIGHT:- 1.200-1.400 kg/12'



ALUMETAL INDUSTRIES

SEC. NO:- 1781

SEC.NO:-AI-316

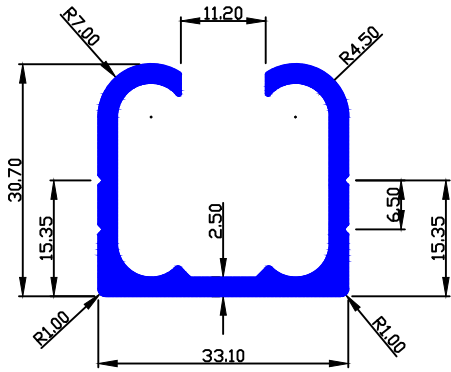

WEIGHT:- 2.650-2.850 kg/12'

SEC. NO:- 1791

SEC.NO:-AI-317

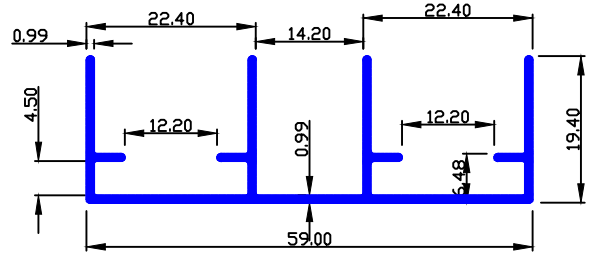

WEIGHT:- 1.450-1.650 kg/12'

SEC. NO:- 1801

SEC.NO:-AI-318

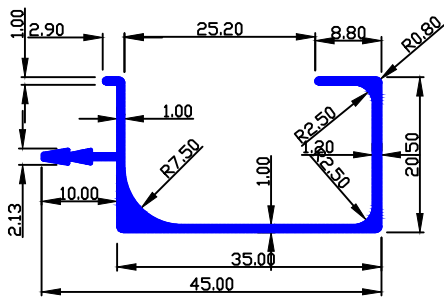

WEIGHT:- 1.140-1.340 kg/12'

SEC. NO:- 1811

SEC.NO:-AI-319

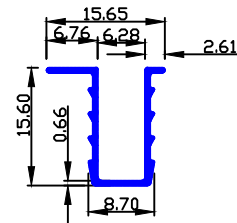

WEIGHT:- 1.200-1.400 kg/12'



ALUMETAL INDUSTRIES

SEC. NO:- 1821

SEC.NO:-AI-320

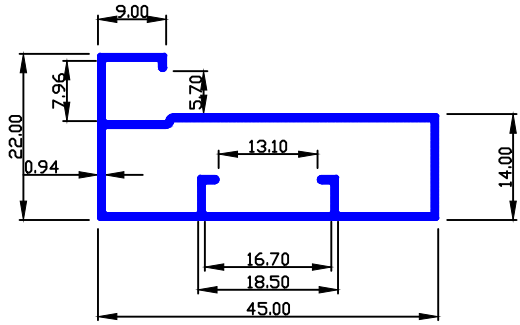

WEIGHT:- 1.340-1.540 kg/12'

SEC. NO:- 1831

SEC.NO:-AI-321

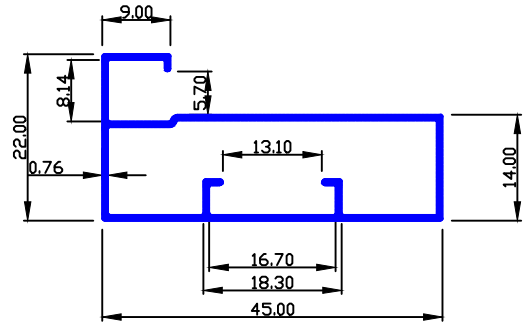

WEIGHT:- 1.100-1.300 kg/12'

SEC. NO:- 1841

SEC.NO:-AI-322

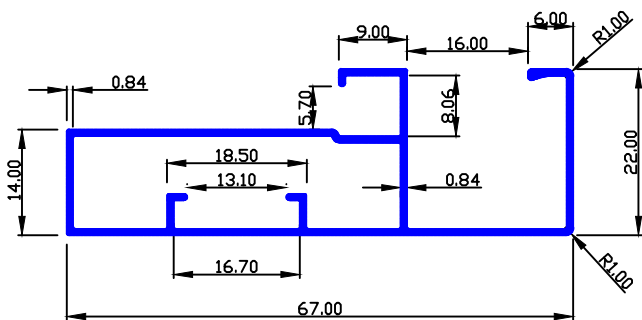

WEIGHT:- 1.600-1.800 kg/12'

SEC. NO:- 1851

SEC.NO:-AI-323

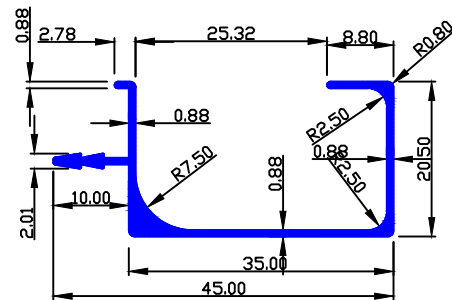

WEIGHT:- 1.000-1.200 kg/12'



ALUMETAL INDUSTRIES

SEC. NO:- 1861

SEC.NO:-AI-324

SEC. NO:- 1871

SEC.NO:-AI-325

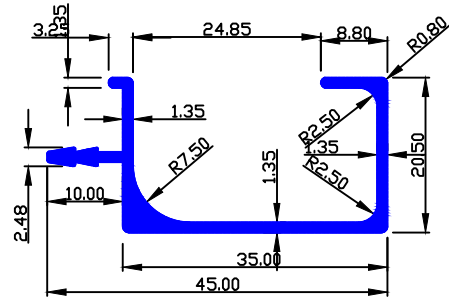
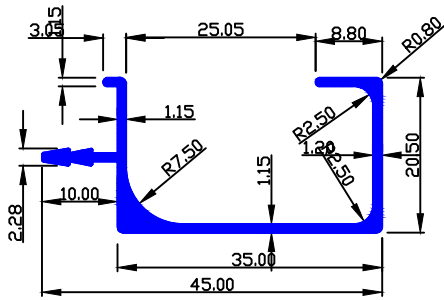

WEIGHT:- 1.240-1.440 kg/12'

WEIGHT:- 1.400-1.600 kg/12'